

# 1 **BRAVILOR BONAMAT**

## *Thermal Brewer Aurora*

- EN User manual
- FR Mode d'emploi utilisateur
- ES Manual del usuario



digital 750F (EN FR ES)

|           |           |           |           |           |
|-----------|-----------|-----------|-----------|-----------|
| GTBSH-001 | GTBSH-002 | GTBSH-003 | GTBSH-004 |           |
| GTBTH-001 | GTBTH-002 | GTBTH-003 | GTBTH-004 |           |
| GTBSL-001 | GTBSL-002 | GTBSL-003 | GTBSL-004 | GTBSH-005 |
| GTBTL-001 | GTBTL-002 | GTBTL-003 | GTBTL-004 |           |



English  
Français  
Español



Information  
Information  
Información



Table of contents  
Table des matières  
Contenido



Handling  
Fonctionnement  
Operación



Container  
Récipient  
Recipiente



Container without base  
Récipient sans base  
Recipiente sin la base



Stop brewing  
Arrêter brassage  
Parar preparación



Water  
Eau  
Agua



Cleaning  
Nettoyage  
Limpiar



Daily cleaning  
Nettoyage quotidien  
Limpieza diaria



Filter pan  
Filtre pan  
Filtro de la cacerola



Clean the spray head  
Nettoyer la tête d'aspersion  
cabezal rociador limpio



Spray head  
Tête d'aspersion  
Cabezal difusor



Programming  
Programmation  
Programación



Messages  
Messages  
Mensajes



Call supplier  
Appelez votre fournisseur  
Llame al proveedor



Wait  
Patienter  
Esperar



Selection  
Sélection  
Selección



ON/OFF switch  
Sur interrupteur  
En del interruptor



Choose container  
Choisir récipient  
Elegir recipiente



Choose recipe  
Choisir recette  
Elegir receta



Choose volume  
Choisir volume  
Elegir volumen



Brewing  
Brassage  
Preparación



Hot liquid  
Liquide chaud  
Líquido caliente



Airpot  
Airpot  
Airpot



Can  
Boîte  
Lata



English  
Français  
Español



Brush  
Brosse  
Sepillar



Moist cloth  
Chiffon humide  
Trapo húmido



Rinse  
Rinçer  
Aclarar



Detergent  
Détergent  
Detergente



Dishwasher proof  
Accepté lave-vaisselle  
Rest. para lavaplatos



Coin  
Pièce  
Moneda



Safety regulations  
Directives de sécurité  
Normas de seguridad



Press MENU  
Appuyer MENU  
Pulsar MENU



Hold MENU  
Maintenir MENU  
Mantener MENU



Press VOLUME  
Appuyer VOLUME  
Pulsar VOLUMEN



Press LEFT/RIGHT  
Appuyer GAUCHE/DROITE  
Pulsar IZQUIERDA/DERECHA



Hold LEFT/RIGHT  
Maintenir GAUCHE/DROITE  
Mantener IZQUIERDA/DERECHA



Press START/STOP  
Appuyer MARCHÉ/ARRÊT  
Pulsar START/STOP



Automatic processing  
Traitement automatique  
Procesamiento automático

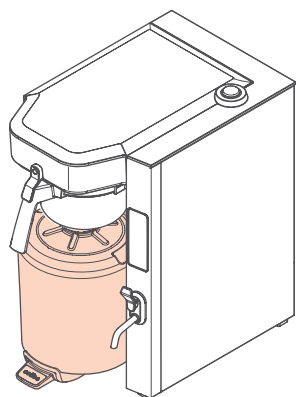

***Aurora Single Low***

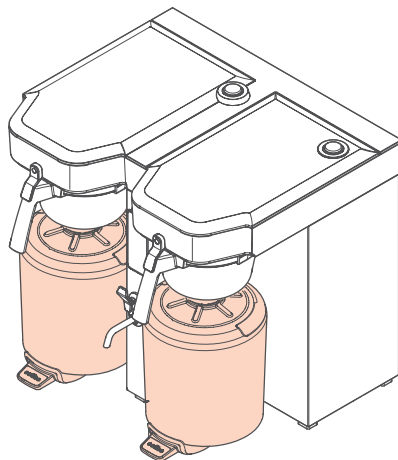

***Aurora Twin Low***

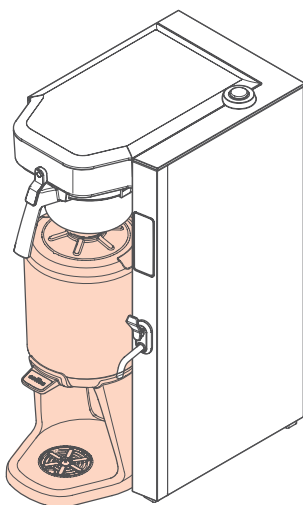

***Aurora Single High***

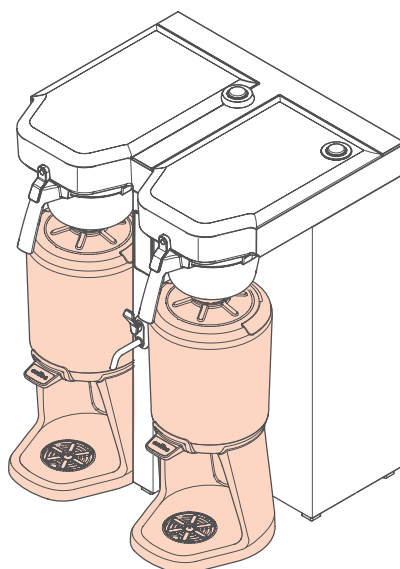

***Aurora Twin High***

**EN**

Please read the enclosed Safety Manual carefully. If the Safety Manual is missing, please visit [www.bravilor.com](http://www.bravilor.com).  
The Operator Manual (part 2) – which is also enclosed – contains the chapters Installation, Descaling and Programming.

















**FR**

Veillez lire attentivement le Manuel de sécurité en annexe.  
En l'absence du Manuel de sécurité, consultez [www.bravilor.com](http://www.bravilor.com).  
Le Manuel opérateur (partie 2), aussi en annexe, contient les chapitres Installation, Détartrage et Programmation.

**ES**

Lea atentamente el Manual de seguridad adjunto. Si falta el Manual de seguridad, visite [www.bravilor.com](http://www.bravilor.com).  
El Manual del operario (parte 2), que también se adjunta, incluye los capítulos Instalación, Descalcificación y Programación.



|   |   |   |           |           |
|---|---|---|-----------|-----------|
|  | _____   | <b>9</b>  |           |           |
|  |    |  | _____     | <b>10</b> |
|  |    | _____   | <b>13</b> |           |
|  |    |  | _____     | <b>14</b> |
|  | _____   | <b>15</b>   |           |           |
|  |    | _____   | <b>16</b> |           |
|  |    |  | _____     | <b>17</b> |
| <b>P</b>  | _____   | <b>19</b>   |           |           |
| <b>E</b>  | _____   | <b>33</b>   |           |           |
| <b>E</b>  |  | _____   | <b>34</b> |           |





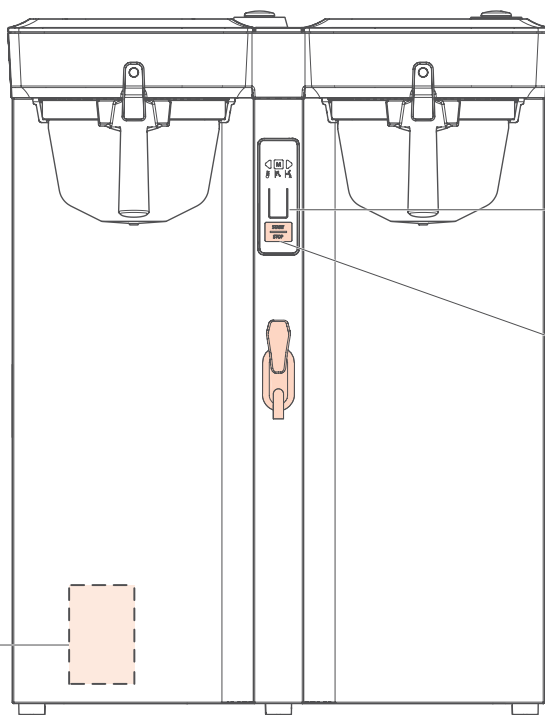
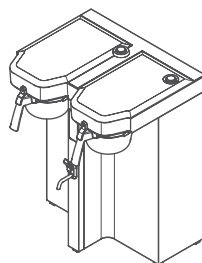
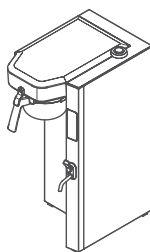
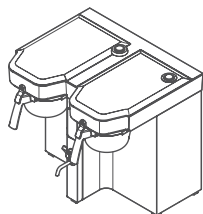
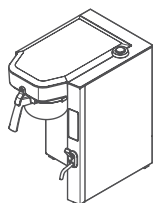

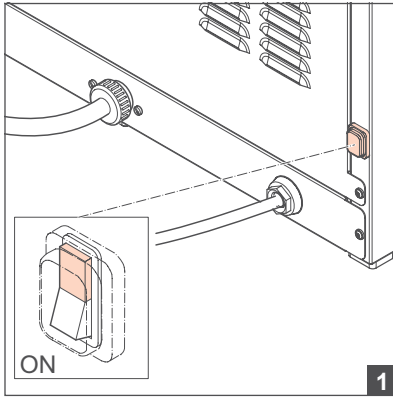

- EN heating
- FR chauffage
- ES calentam.

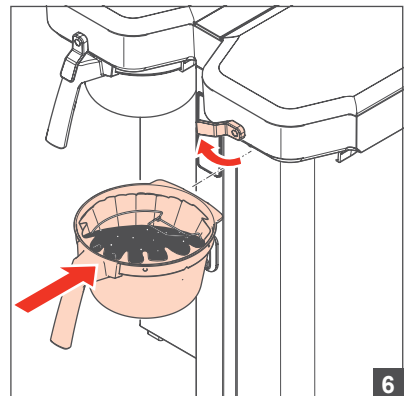
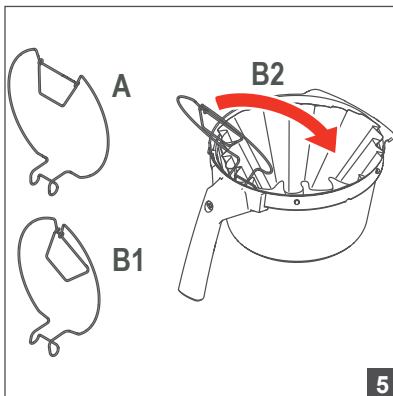
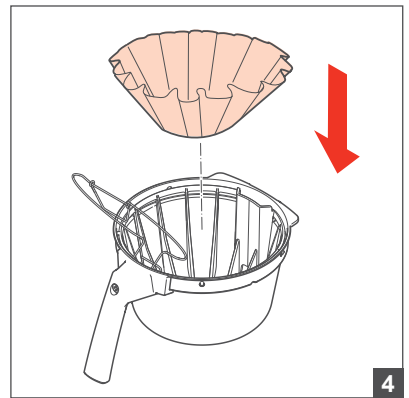
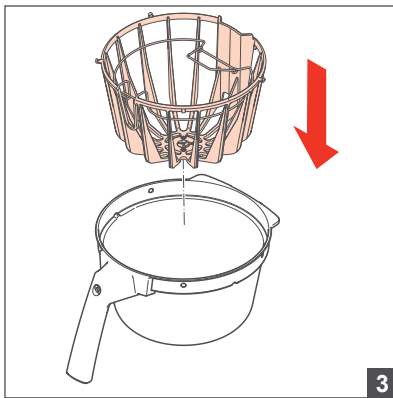
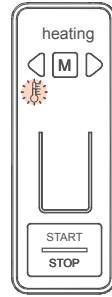

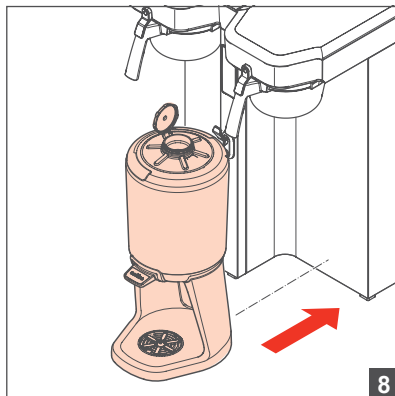
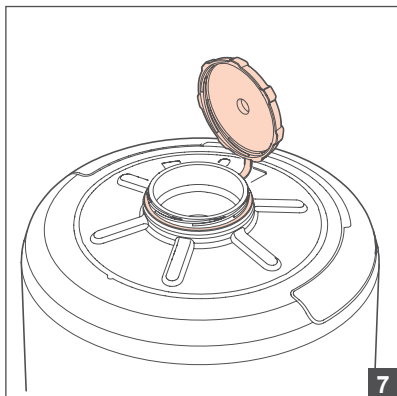

- EN ## gallon  
"recipe x"
- FR ## gallons  
"recette x"
- ES ## galones  
"receta x"

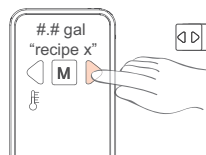
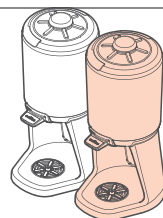
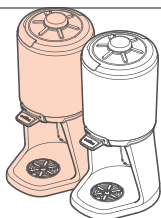

9



- EN ## litre  
"recipe x/y/z"
- FR ## litre  
"recette x/y/z"
- ES ## litre  
"receta x/y/z"

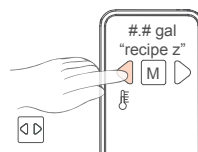
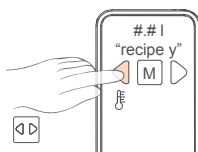
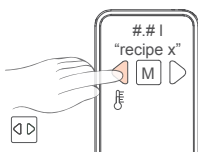
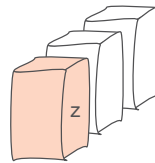
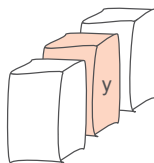
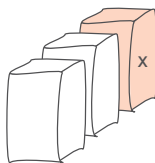

10



EN ## litre  
"recipe x"  
FR ## litre  
"recette x"  
ES ## litro  
"receta x"

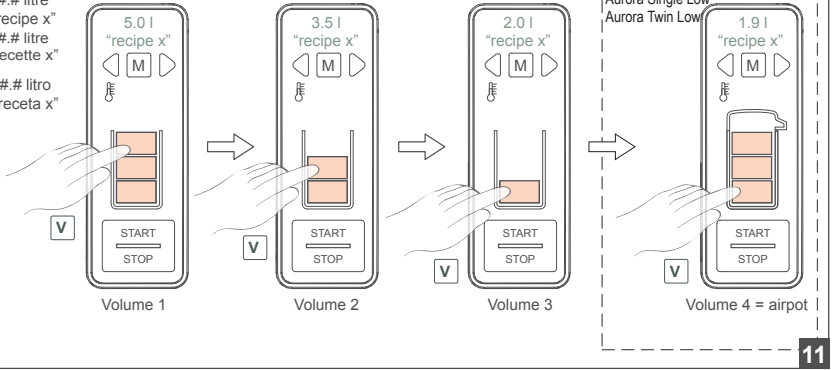

EN ## litre  
"recipe x"  
FR ## litre/brassage  
"recette x"  
ES ## litro/prep.  
"receta x"

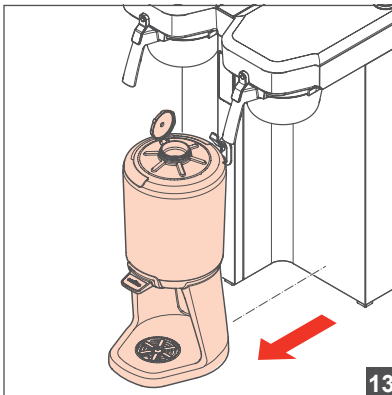
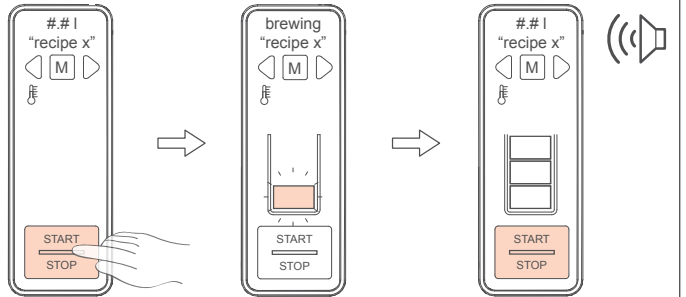



- EN brewing aborted
- FR brassage interrompu
- ES prep. cancelado

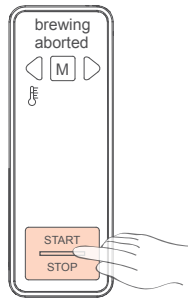

1

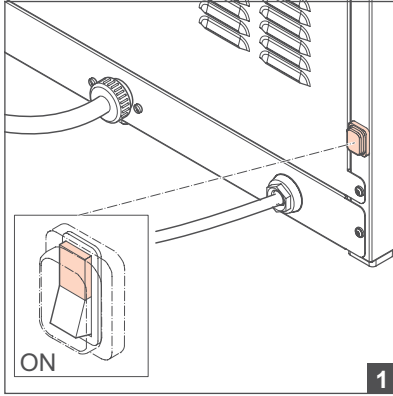

EN heating  
FR chauffage  
ES calentam.

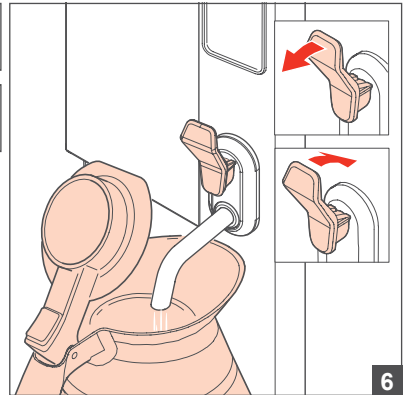
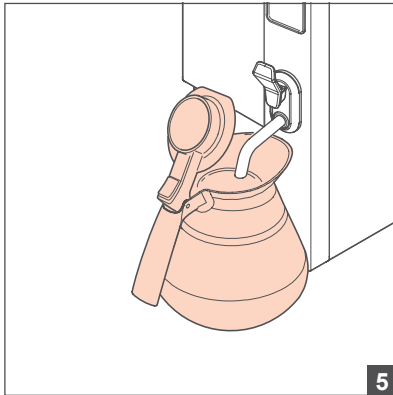
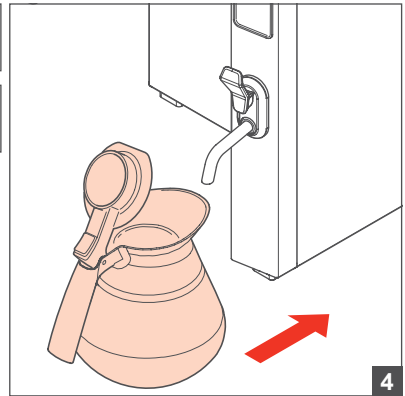
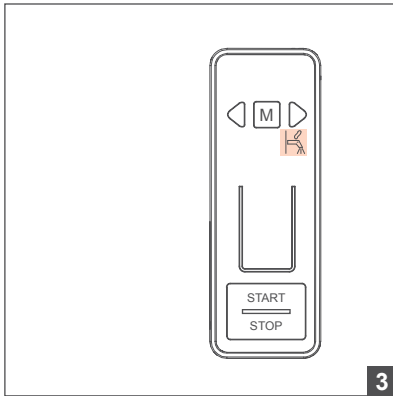
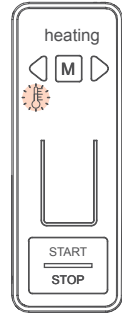

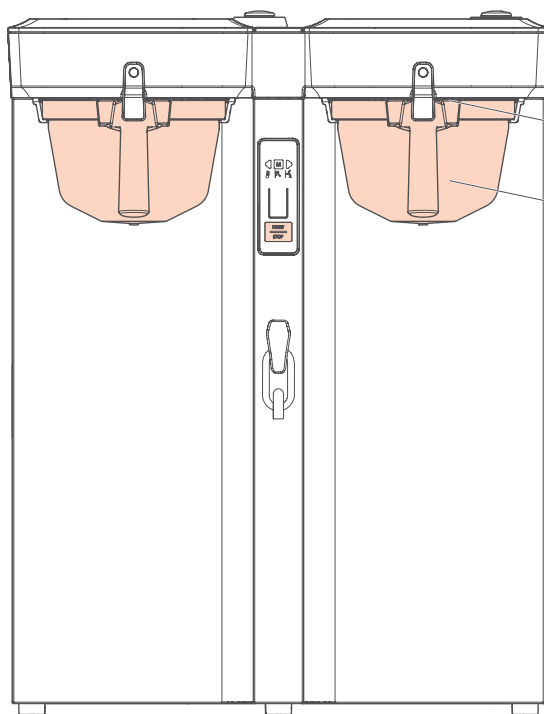
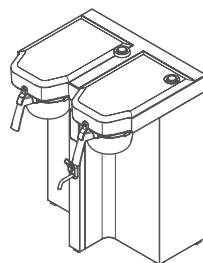
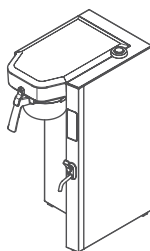
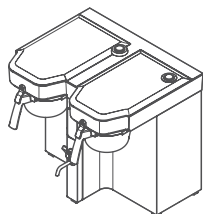
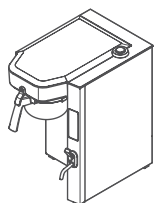

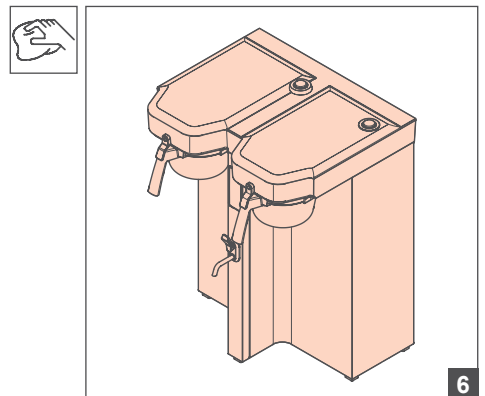
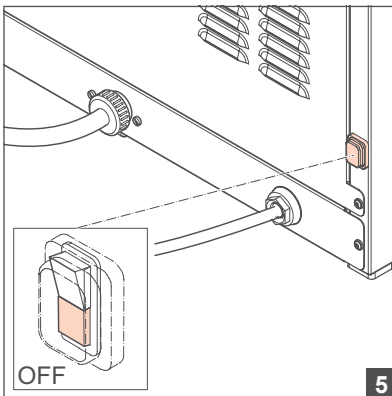
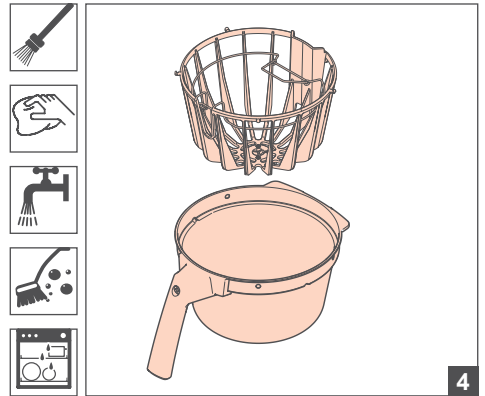
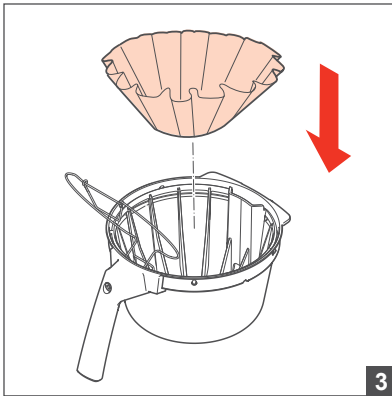
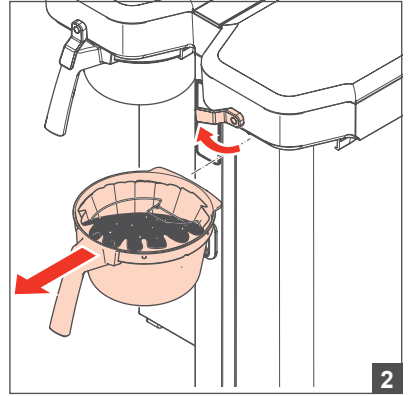
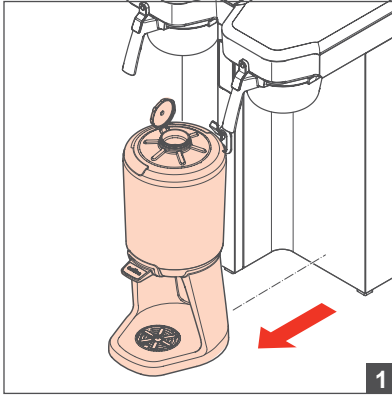



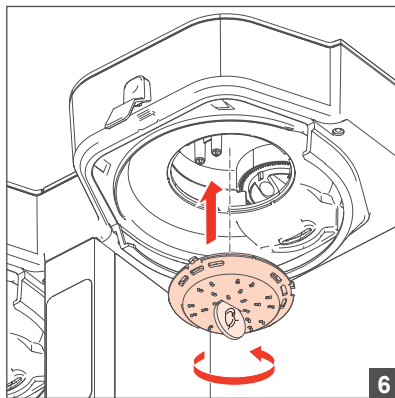
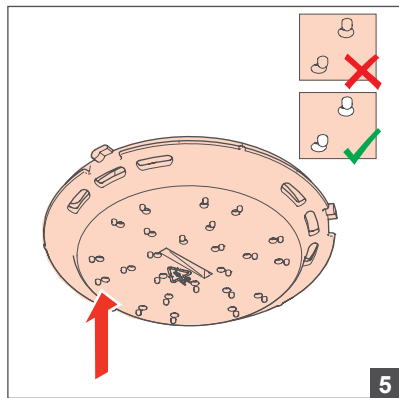
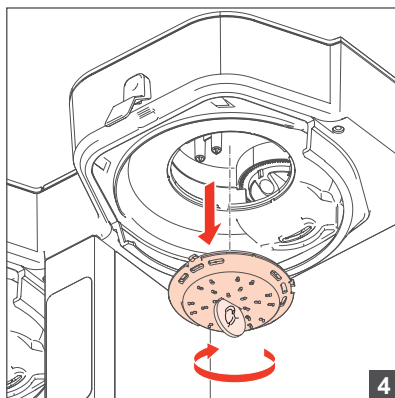
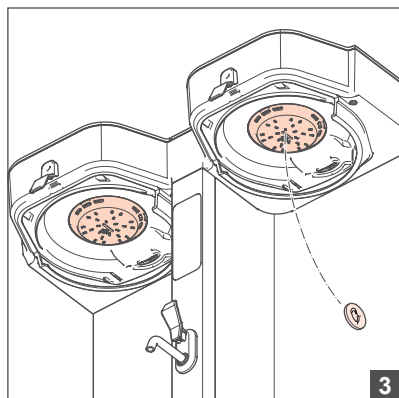
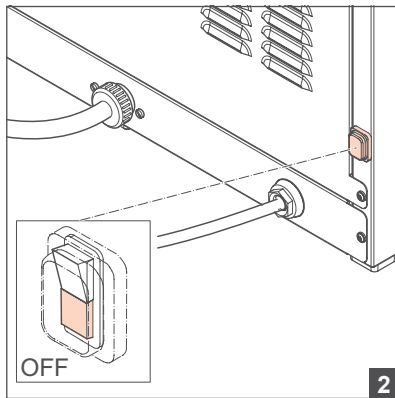
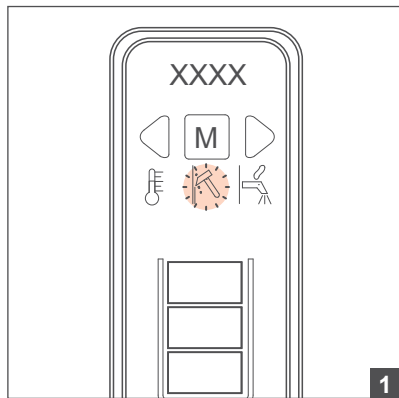



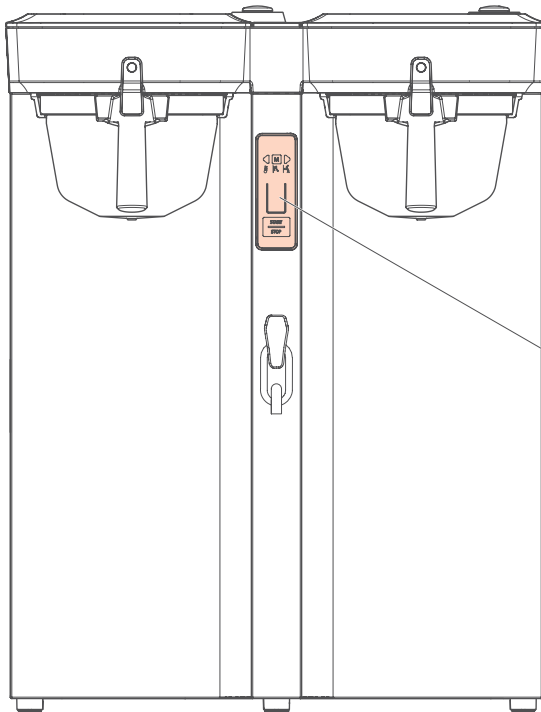
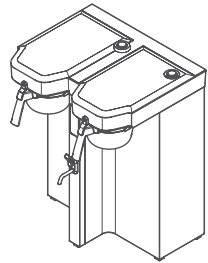
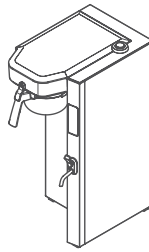
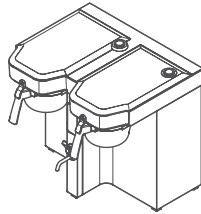
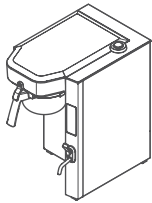

## DISPLAY

The display helps to communicate with the machine, with buttons and a text window.

### Text window

The text window (1) can show:

- menus
- items in the menu
- settings
- commands
- automatic procedures

If you have the twin machine, the black arrow (2) indicates whether you operate the left or the right brewer.

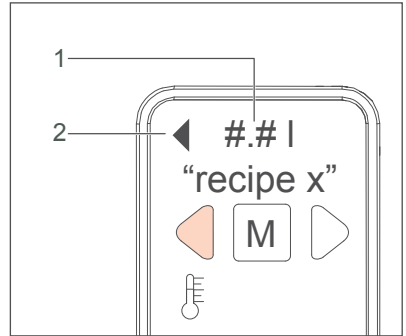

### Buttons

With the buttons you can navigate through the menus of the machine.

1. MENU button
2. LEFT/RIGHT button
3. VOLUME button
4. START/STOP

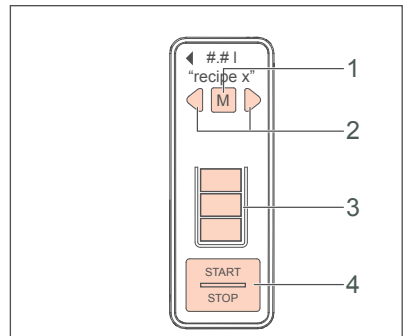

### Menus

The basic operation has menus for:

- the selection of the recipe
- how to change the amount of coffee you brew
- start or stop the machine

In the operator menus, you can define your preferences. In the menu you can:

- build, change, download or upload recipes
- change the setting of the temperature, calendar, time, machines
- change the setting of the programs of the machine, such as:
  - Eco
  - Water filter
  - Descaling
  - Cleaning

## Navigation

Touch the buttons for navigation.

Two different ways of touching the button are defined in this manual:

- Press a button: briefly touch the button.
- Hold a button: touch the button for at least 1 seconds.

Each different way of touching a button results in a different action in the display navigation.

## Button Commands

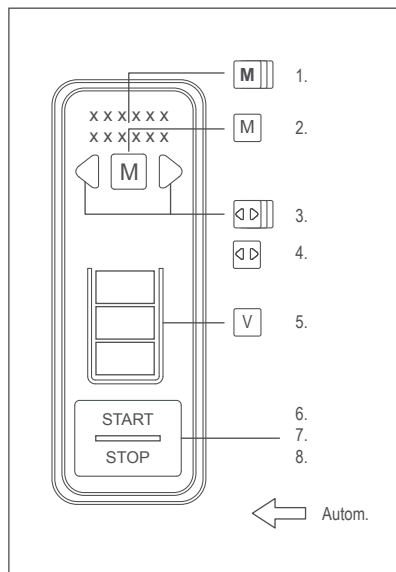

1. Hold the MENU button 1 second to confirm a choice in a menu level.
2. Press the MENU button briefly to proceed to the next menu level.
3. Hold the LEFT/RIGHT button to switch brewer (only in a TWIN version).
4. Press the LEFT/RIGHT button briefly to scroll through the options of the menu level.
5. Press the VOLUME button briefly to change the volume you brew.
6. Hold the START/STOP button to start brewing.
7. Hold or press the START/STOP button to abort the brewing process.
8. Press the START/STOP button briefly to go back one menu level.

## Automatic procedures

White arrows in the scheme indicate automatic procedures, performed by the machine.

EN

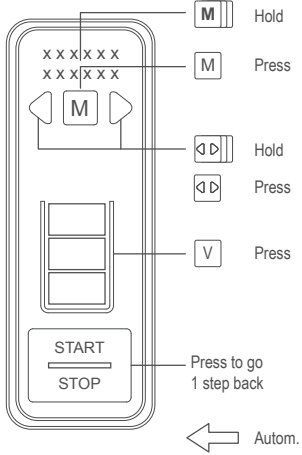

- Twin versions
- Optional or for low versions only
- ” xx ” Fixed value
- [ xx ] You can change this value

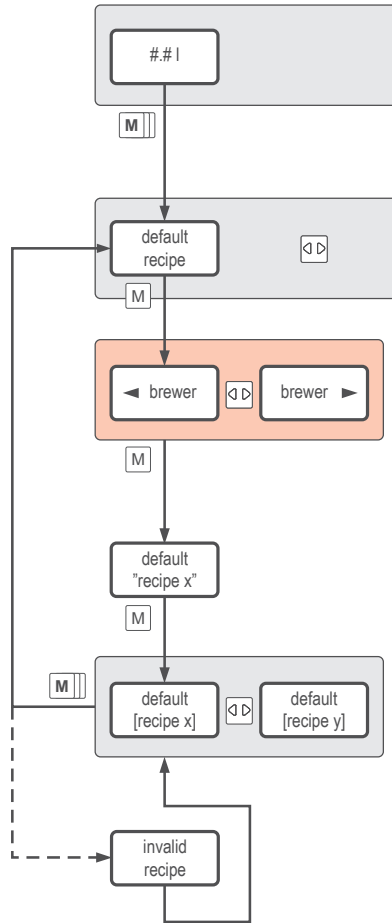

1 User menu

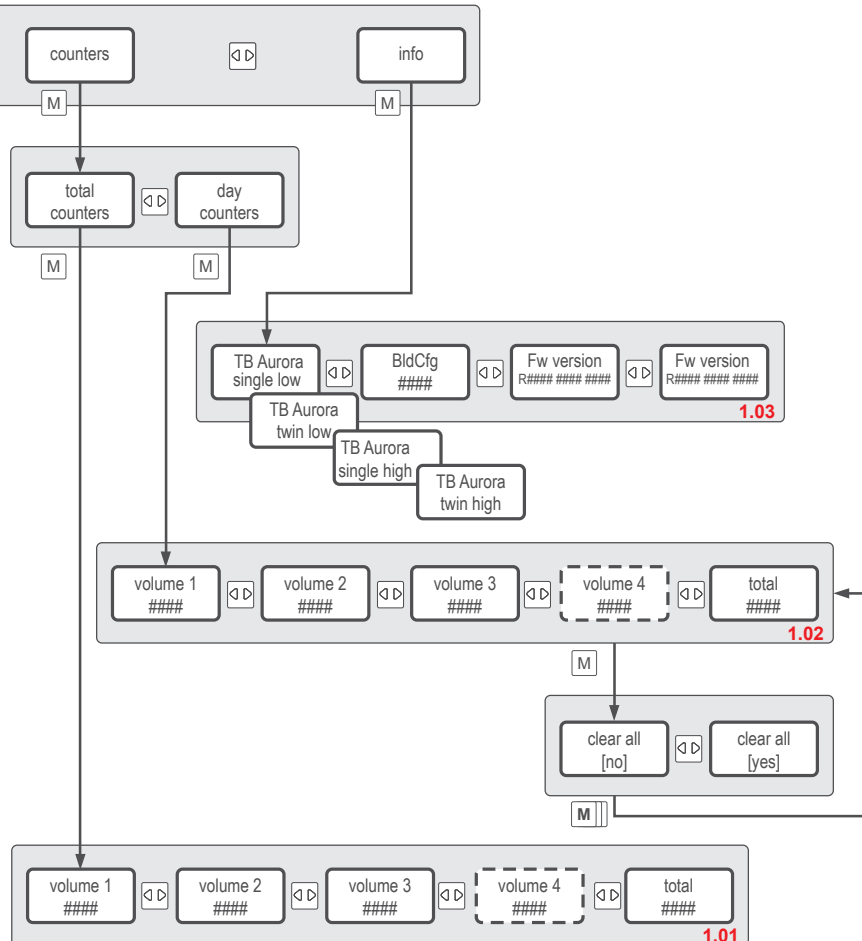
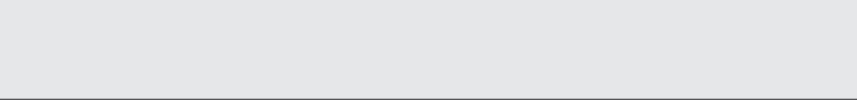

## AFFICHAGE

L'affichage permet de communiquer avec la machine à l'aide de boutons et de textes affichés.

### Fenêtre de texte

La fenêtre de texte (1) peut afficher :

- menus
- éléments de menu
- réglages
- commandes
- procédures automatiques

Si vous avez une machine double, la flèche noire (2) indique si vous utilisez le brasseur de gauche ou de droite.

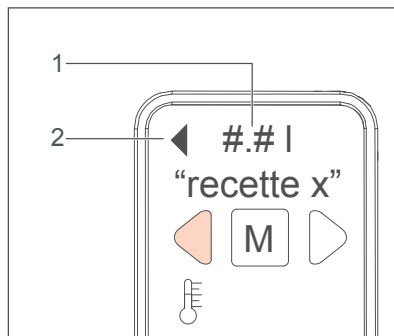

### Boutons

Utilisez les boutons afin de parcourir les menus de la machine.

1. Bouton MENU
2. Bouton GAUCHE/DROITE
3. Bouton VOLUME
4. MARCHE/ARRÊT

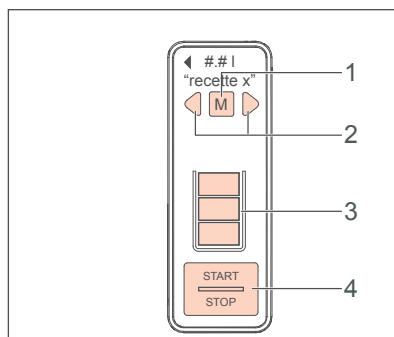

### Menus

Le fonctionnement basique dispose de menus pour :

- la sélection de la recette
- la méthode de modification de la quantité de café brassée
- démarrer ou arrêter la machine

Dans les menus de l'opérateur, vous pouvez définir vos préférences. Dans les menus, vous pouvez :

- créer, changer, télécharger ou charger des recettes
- changer les réglages de température, calendrier, heure, machines
- changer les réglages des programmes de la machine, ainsi :
  - Éco
  - Filtre à eau
  - Détartrage
  - Nettoyage



### Navigation

Touchez les boutons pour la navigation.

Ce manuel définit deux manières différentes de toucher les boutons :

- Appuyer sur un bouton : touchez brièvement le bouton.
- Maintenir un bouton : touchez un bouton pendant au moins 1 seconde.

Chaque méthode de touche de bouton génère une action différente dans la navigation des affichages.

### Commandes de bouton

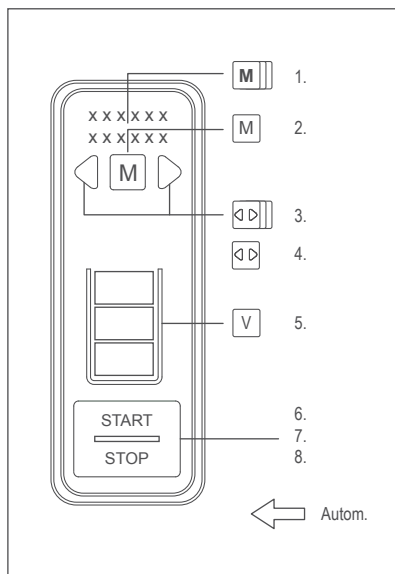

1. Maintenez le bouton MENU 1 seconde pour confirmer un choix de niveau de menu.
2. Appuyez brièvement sur le bouton MENU pour passer au niveau de menu suivant.
3. Maintenez le bouton GAUCHE/DROITE pour changer de brasseur (uniquement pour la version double).
4. Appuyez brièvement sur le bouton GAUCHE/DROITE pour faire défiler les options de niveau de menu.
5. Appuyez brièvement sur le bouton VOLUME pour changer le volume brassé.
6. Maintenez le bouton MARCHE/ARRÊT pour démarrer le brassage.
7. Maintenez ou appuyez sur le bouton MARCHE/ARRÊT pour interrompre le processus de brassage.
8. Appuyez brièvement sur le bouton MARCHE/ARRÊT pour reculer d'un niveau de menu.

### Procédures automatiques

Les flèches blanches du schéma indique les procédures automatiques exécutées par la machine.

FR

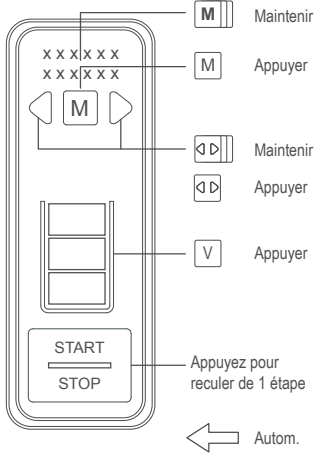

- Versions double
- Option ou pour versions basses uniquement
- ” xx ” Valeur fixe
- [ xx ] Vous pouvez changer cette valeur

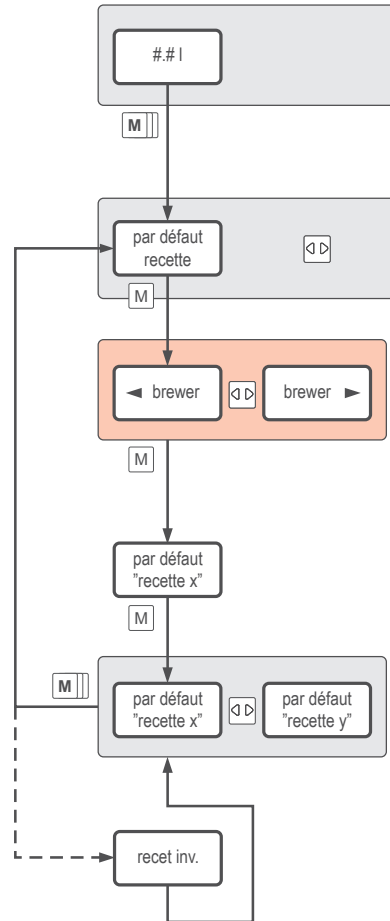

1 Menu utilisateur

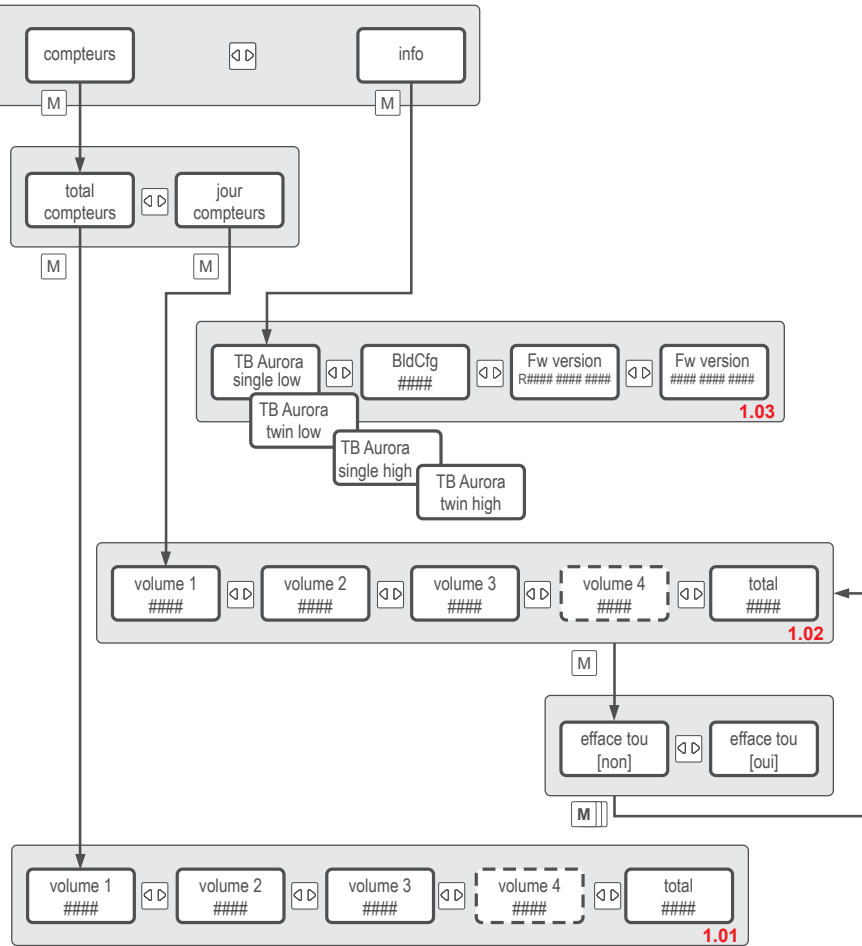

## PANTALLA

La pantalla ayuda a comunicar con la máquina mediante los botones y una ventana de texto.

### Ventana de texto

La ventana de texto (1) puede mostrar:

- menús
- elementos en el menú
- ajustes
- comandos
- procedimientos automáticos

Si tiene la máquina doble, la flecha negra (2) indica si está funcionando el expendedor izquierdo o derecho.

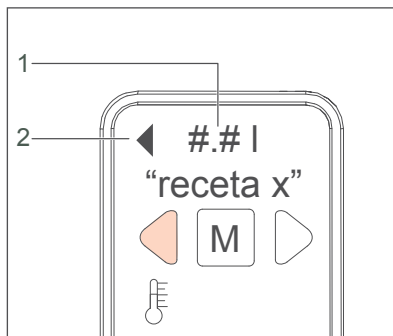

### Botones

Con los botones puede navegar por los menús de la máquina.

1. Botón MENÚ
2. Botón IZQUIERDA/DERECHA
3. Botón VOLUMEN
4. START/STOP

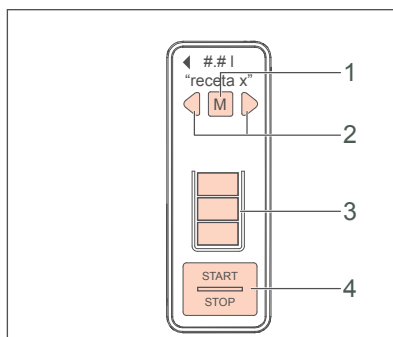

### Menús

El funcionamiento básico tiene menús para:

- la selección de la receta
- cómo cambiar la cantidad de café que prepara
- poner en marcha o parar la máquina

En los menús del operario puede definir sus preferencias. En los menús es posible:

- crear, cambiar, descargar o subir recetas
- cambiar el ajuste de la temperatura, el calendario, la hora, las máquinas
- cambiar el ajuste de los programas de la máquina, como:
  - Eco
  - Filtro agua
  - Descalcificación
  - Limpieza

### Navegación

Toque los botones para la navegación.

En este manual se definen dos formas diferentes de tocar el botón:

- Pulsar un botón: tocar brevemente el botón.
- Mantener un botón: tocar el botón durante al menos 1 segundo.

Cada forma diferente de tocar un botón resulta en una acción diferente en la navegación en pantalla.

### Comandos de los botones

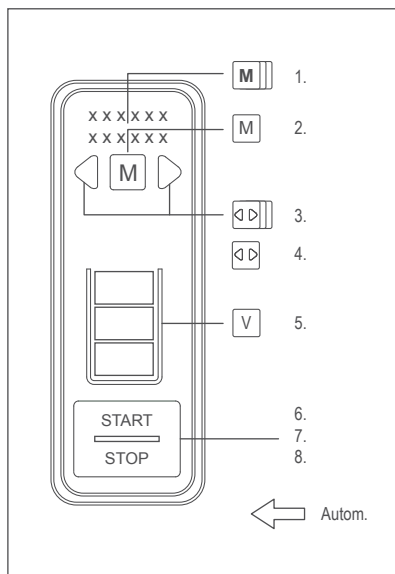

1. Mantenga el botón MENÚ 1 segundo para confirmar una selección en un nivel de menú.
2. Pulse el botón MENÚ brevemente para continuar al siguiente nivel de menú.
3. Mantenga el botón IZQUIERDA/DERECHA para cambiar de expendedor (solo en una versión DOBLE).
4. Pulse el botón IZQUIERDA/DERECHA brevemente para desplazarse por las opciones del nivel de menú.
5. Pulse el botón VOLUMEN brevemente para cambiar el volumen que prepara.
6. Mantenga el botón START/STOP para empezar a preparar.
7. Mantenga o pulse el botón START/STOP para cancelar el proceso de preparación.
8. Pulse el botón START/STOP brevemente para regresar un nivel de menú.

### Procedimientos automáticos

Las flechas blancas en el esquema indican procedimientos automáticos, realizados por la máquina.

ES

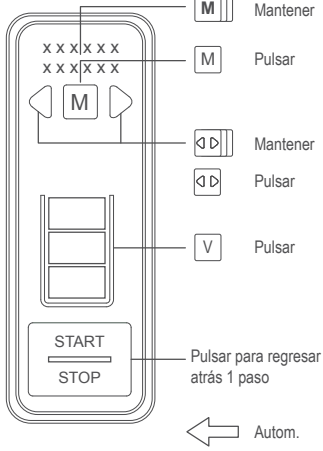

- Versiones dobles
- Opcional o solo para versiones bajas
- ” xx ” Valor fijo
- [ xx ] Puede cambiar este valor

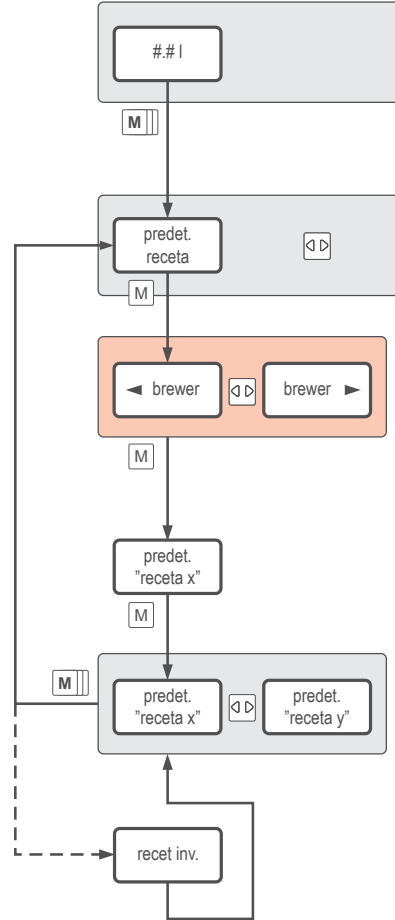

1 Menú del usuario

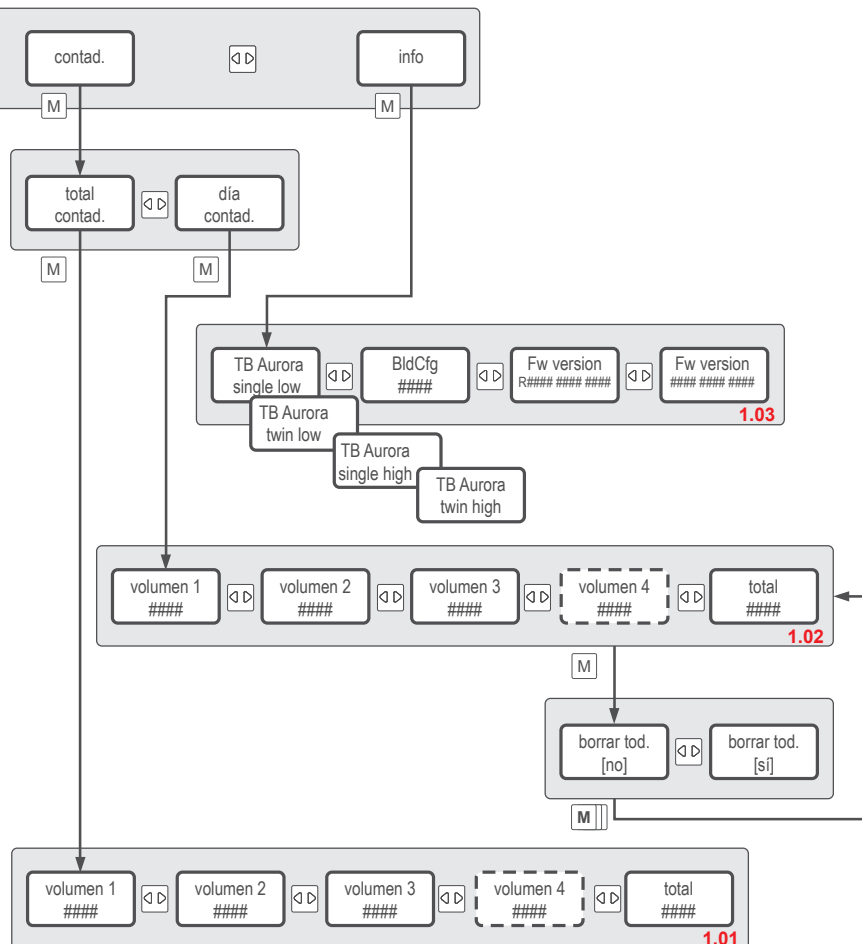





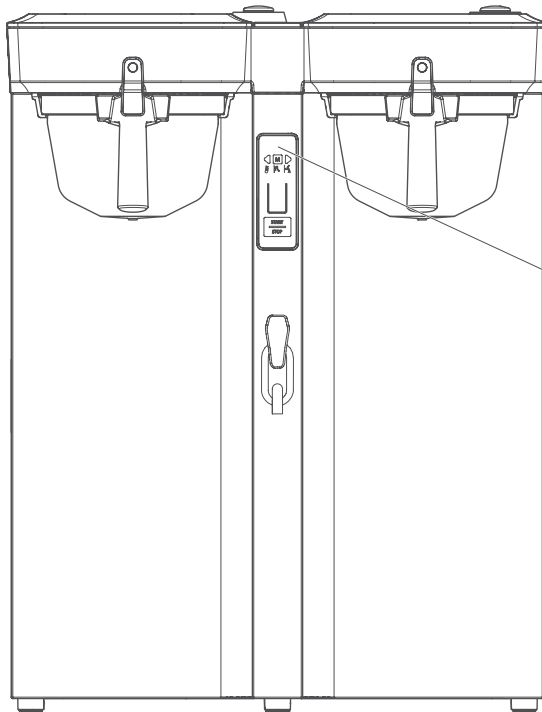
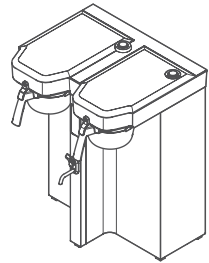
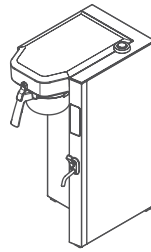
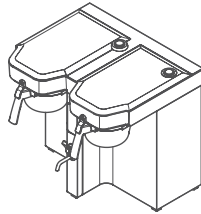
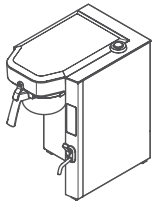

**E**

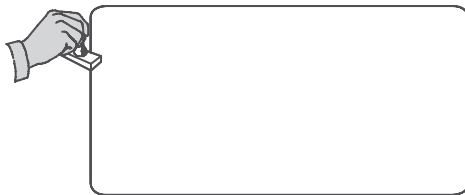
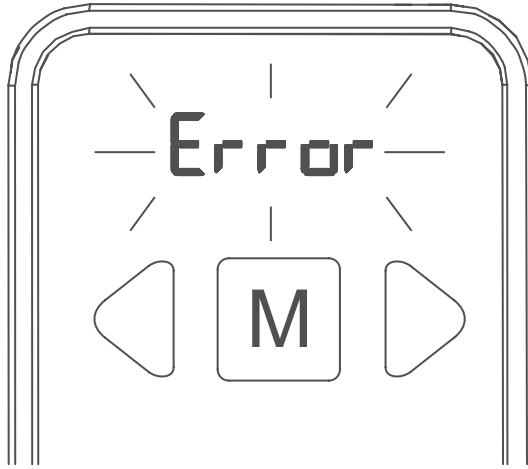





**/// BRAVILOR  
BONAMAT**

© 02 - 2022

VHH

